

Advanced Low Power 5V RS232 Transceiver with Small Capacitors

FEATURES

- **Low Cost**
- Uses Small Capacitors: 0.1 μ F, 0.2 μ F
- **1 μ A Supply Current in Shutdown**
- 120kbaud Operation for $R_L = 3k$, $C_L = 2500pF$
- **250kbaud Operation for $R_L = 3k$, $C_L = 1000pF$**
- CMOS Comparable Low Power: 40mW
- Operates from a Single 5V Supply
- Easy PC Layout: Flow-through Architecture
- Rugged Bipolar Design
- Outputs Assume a High Impedance State When Off or Powered Down
- Improved Protection: RS232 I/O Lines Can Be Forced to $\pm 25V$ Without Damage
- Output Overvoltage Does Not Force Current Back into Supplies
- Absolutely No Latch-Up
- Available in SO Package

APPLICATIONS

- Notebook Computers
- Palmtop Computers

DESCRIPTION

The LT[®]1537 is a three-driver, five-receiver RS232 transceiver, pin compatible with the LT1137A, offering performance improvements and two shutdown modes. The LT1537's charge pump is designed for extended compliance and can deliver over 35mA of load current. Supply current is typically 8mA, competitive with similar CMOS devices. An advanced driver output stage operates up to 250kbaud while driving heavy capacitive loads.

The LT1537 is fully compliant with all RS232 specifications. Special bipolar construction techniques protect the drivers and receivers beyond the fault conditions stipulated for RS232. Driver outputs and receiver inputs can be shorted to $\pm 25V$ without damaging the device or the power supply generator. In addition, the RS232 I/O pins are resilient to multiple $\pm 5kV$ ESD strikes.

The transceiver has two shutdown modes. One mode disables the drivers and the charge pump, the other shuts down all circuitry. While shut down, the drivers and receivers assume high impedance output states.

LT, LTC and LT are registered trademarks of Linear Technology Corporation.

TYPICAL APPLICATION

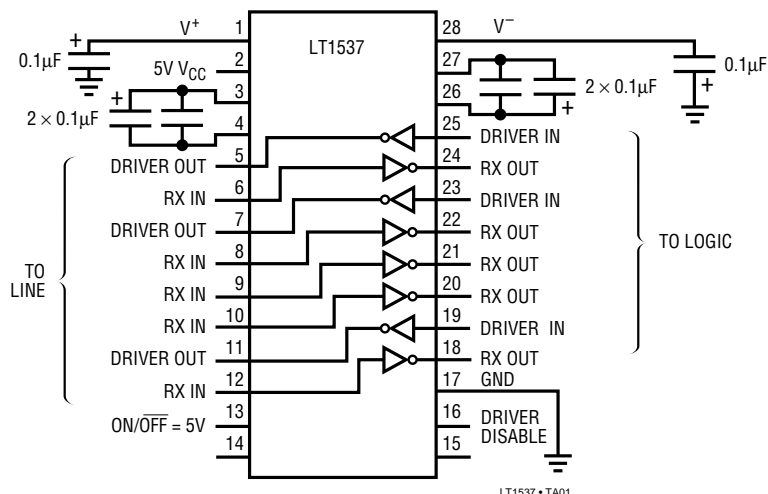

Output Waveforms

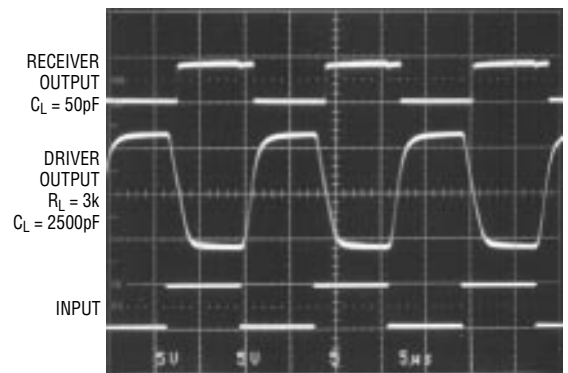

LT1537 • TA02

ABSOLUTE MAXIMUM RATINGS

(Note 1)

Supply Voltage (V_{CC})	5.5V
V^+	13.2V
V^- (Note 7)	-6.5V
Input Voltage	
Driver	V^- to V^+
Receiver	-25V to 25V
Output Voltage	
Driver	$V^+ - 25V$ to $V^- + 25V$
Receiver	-0.3V to $V_{CC} + 0.3V$
Short Circuit Duration	
V^+	30 sec
V^-	30 sec
Driver Output	Indefinite
Receiver Output	Indefinite
Operating Temperature Range	
LT1537C	0°C to 70°C
Storage Temperature Range	-65°C to 150°C
Lead Temperature (Soldering, 10 sec)	300°C

PACKAGE/ORDER INFORMATION

<p>G PACKAGE 28-LEAD PLASTIC SSOP</p> <p>SW PACKAGE 28-LEAD PLASTIC SO WIDE</p> <p>$T_{JMAX} = 150^\circ\text{C}$, $\theta_{JA} = 96^\circ\text{C/W}$ (G) $T_{JMAX} = 150^\circ\text{C}$, $\theta_{JA} = 85^\circ\text{C/W}$ (SW)</p>	ORDER PART NUMBER
	<p>LT1537CG LT1537CSW</p>

Consult factory for Industrial and Military grade parts.

ELECTRICAL CHARACTERISTICS (Note 2)

PARAMETER	CONDITIONS	MIN	TYP	MAX	UNITS
Power Supply Generator					
V^+ Output			8.6		V
V^- Output			-7.0		V
Supply Current (V_{CC})	(Note 3)	●	8	17	mA
Supply Current When OFF (V_{CC})	Shutdown (Note 4) DRIVER DISABLE	●	1.0 1.5	10	μA mA
Shutdown to Turn-On	C^+ , $C^- = 0.1\mu\text{F}$, $C1$, $C2 = 0.2\mu\text{F}$		0.2		ms
ON/OFF Pin Thresholds	Input LOW Level (Device Shutdown) Input HIGH Level (Device Enabled)	● ●	1.4 1.4	0.8	V V
ON/OFF Pin Current	$0V \leq V_{ON/OFF} \leq 5V$	●	-15	80	μA
Driver Disable Pin Thresholds	Input LOW Level (Drivers Enabled) Input HIGH Level (Drivers Disabled)	● ●	1.4 1.4	0.8	V V
Driver Disable Pin Current	$0V \leq V_{DRIVER\ DISABLE} \leq 5V$	●	-10	500	μA
Oscillator Frequency			130		kHz
Any Driver					
Output Voltage Swing	Load = 3k to GND		5.0	7.5 -6.3 -5.0	V V
Logic Input Voltage Level	Input LOW Level ($V_{OUT} = \text{HIGH}$) Input HIGH Level ($V_{OUT} = \text{LOW}$)	● ●	1.4 2	0.8	V V
Logic Input Current	$0.8V \leq V_{IN} \leq 2V$	●	5	20	μA
Output Short-Circuit Current	$V_{OUT} = 0V$		± 17		mA

ELECTRICAL CHARACTERISTICS (Note 2)

PARAMETER	CONDITIONS	MIN	TYP	MAX	UNITS	
Any Driver						
Output Leakage Current	Shutdown $V_{OUT} = \pm 15V$ (Note 4)	●	10	100	μA	
Data Rate	$R_L = 3k, C_L = 2500pF$ $R_L = 3k, C_L = 1000pF$	120 250			kBaud kBaud	
Slew Rate	$R_L = 3k, C_L = 51pF$ $R_L = 3k, C_L = 2500pF$	4	15 15	30	$V/\mu s$ $V/\mu s$	
Propagation Delay	Output Transition t_{HL} HIGH to LOW (Note 5) Output Transition t_{LH} LOW to HIGH		0.6 0.5	1.3 1.3	μs μs	
Any Receiver						
Input Voltage Thresholds	Input LOW Threshold ($V_{OUT} = HIGH$) Input HIGH Threshold ($V_{OUT} = LOW$)	● ●	0.8 1.7	1.3 2.4	V V	
Hysteresis		●	0.1	0.4	1.0	V
Input Resistance	$V_{IN} = \pm 10V$		3	5	7	$k\Omega$
Output Voltage	Output LOW, $I_{OUT} = -1.6mA$ Output HIGH, $I_{OUT} = 160\mu A$ ($V_{CC} = 5V$)	● ●		0.2 4.2	0.4	V V
Output Leakage Current	Shutdown (Note 4) $0 \leq V_{OUT} \leq V_{CC}$	●		1	10	μA
Output Short-Circuit Current	Sinking Current, $V_{OUT} = V_{CC}$ Sourcing Current, $V_{OUT} = 0V$		10	-20 20	-10	mA mA
Propagation Delay	Output Transition t_{HL} HIGH to LOW (Note 6) Output Transition t_{LH} LOW to HIGH			250 350	600 600	ns ns

The ● denotes specifications which apply over the operating temperature range ($0^\circ C \leq T_A \leq 70^\circ C$ for commercial grade and $-40^\circ C \leq T_A \leq 85^\circ C$ for industrial grade).

Note 1: Absolute Maximum Ratings are those values beyond which the life of the device may be impaired.

Note 2: Testing done at $V_{CC} = 5V$ and $V_{ON/OFF} = 3V$. $C_1 = C_2 = 0.2\mu F$, $C^+ = C^- = 0.1\mu F$.

Note 3: Supply current is measured with driver and receiver outputs unloaded and the driver inputs tied high.

Note 4: Supply current and leakage current measurements in shutdown are performed with $V_{ON/OFF} = 0.1V$. Supply current measurements using DRIVER DISABLE are performed with $V_{DRIVER\ DISABLE} = 3V$.

Note 5: For driver delay measurements, $R_L = 3k$ and $C_L = 51pF$. Trigger points are set between the driver's input logic threshold and the output transition to the zero crossing ($t_{HL} = 1.4V$ to $0V$ and $t_{LH} = 1.4V$ to $0V$).

Note 6: For receiver delay measurements, $C_L = 51pF$. Trigger points are set between the receiver's input logic threshold and the output transition to standard TTL/CMOS logic threshold ($t_{HL} = 1.3V$ to $2.4V$ and $t_{LH} = 1.7V$ to $0.8V$).

Note 7: Absolute maximum externally applied voltage. Internal charge pump may force a larger value on this pin.

TYPICAL PERFORMANCE CHARACTERISTICS

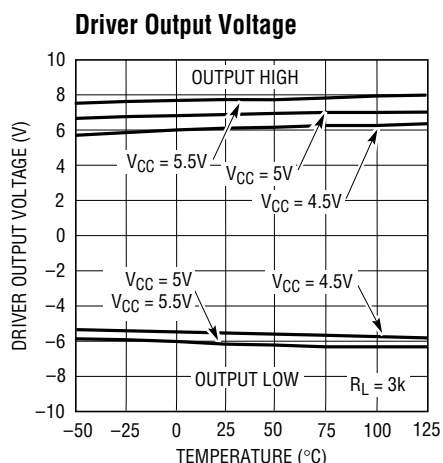

LT1537 • TPC01

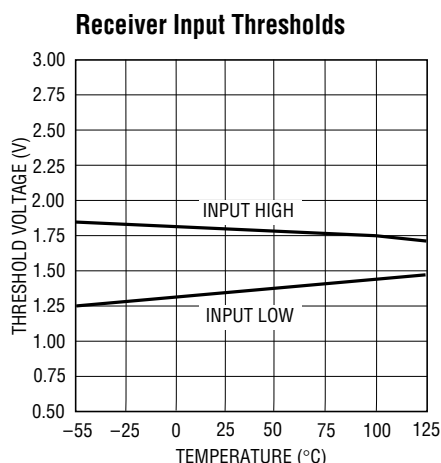

LT1537 • TPC02

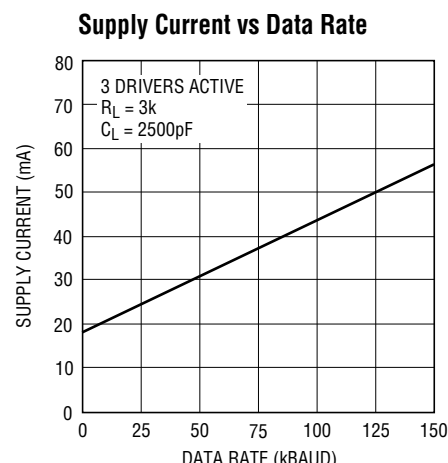

LT1537 • TPC03

TYPICAL PERFORMANCE CHARACTERISTICS

Positive Supply Output Compliance Curve

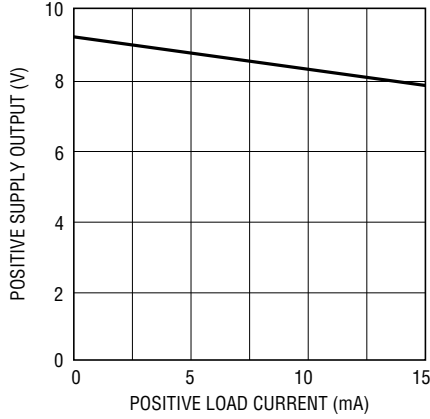

LT1537 • TPC04

Negative Supply Output Compliance Curve

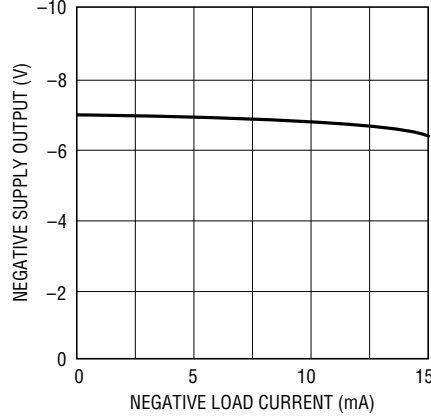

LT1537 • TPC05

Driver Disable Threshold

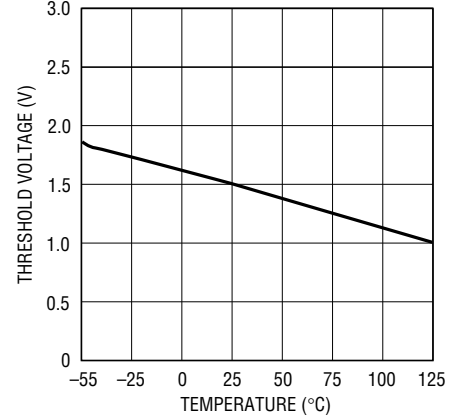

LT1537 • TPC06

On/Off Thresholds

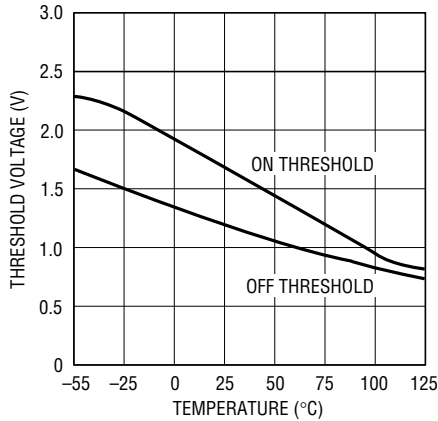

LT1537 • TPC07

Supply Current

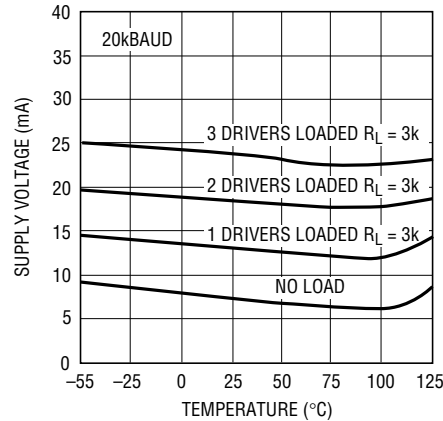

LT1537 • TPC08

Driver Leakage in Shutdown

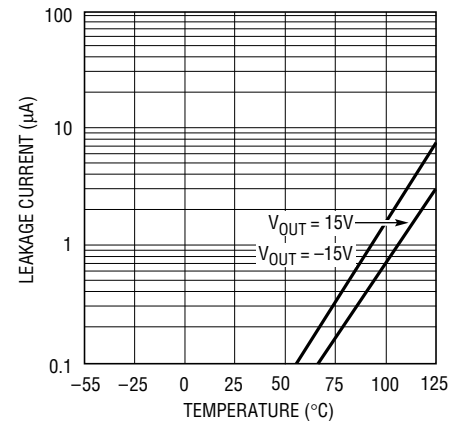

LT1537 • TPC09

Driver Output Short-Circuit Current

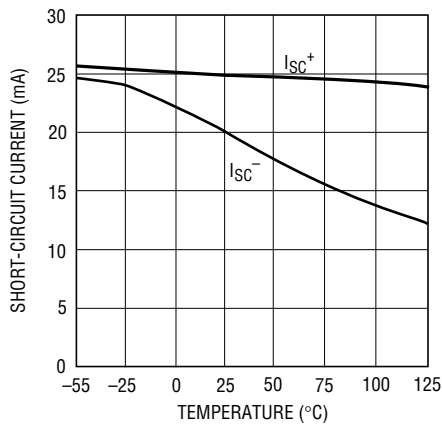

LT1537 • TPC10

Receiver Short-Circuit Current

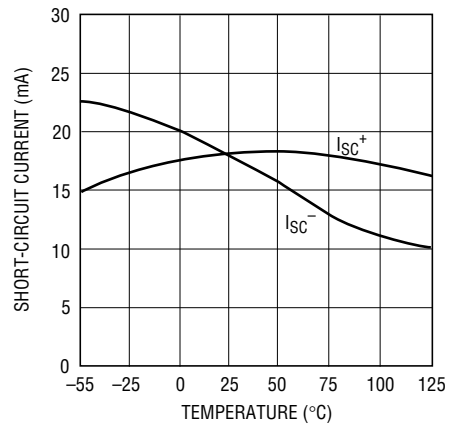

LT1537 • TPC11

TYPICAL PERFORMANCE CHARACTERISTICS

Shutdown to Driver Output

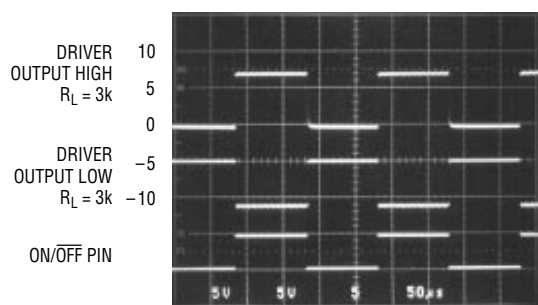

LT1537 • TPC12

Driver Output Waveforms

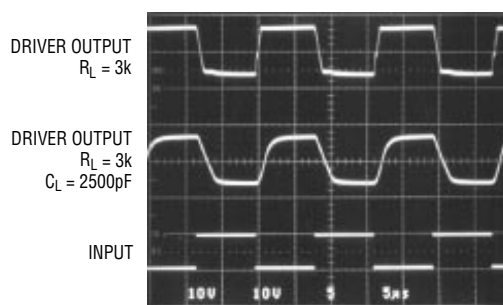

LT1537 • TPC13

PIN FUNCTIONS

V_{CC}: 5V Input Supply Pin. Supply current drops to zero in the shutdown mode. This pin should be decoupled with a 0.1µF ceramic capacitor close to the package pin. Insufficient supply bypassing can result in low output drive levels and erratic charge pump operation.

GND: Ground Pin.

ON/OFF: TTL/CMOS Compatible Operating Mode Control. A logic LOW puts the device in the shutdown mode which reduces input supply current to zero and places all of the drivers and receivers in high impedance state. A logic HIGH fully enables the transceiver.

DRIVER DISABLE: This pin provides an alternate control for the charge pump and RS232 drivers. A logic HIGH on this pin shuts down the charge pump and places all drivers in a high impedance state. Receivers remain active under these conditions. Floating the driver disable pin or driving it to a logic LOW level fully enables the transceiver. A logic LOW on the On/Off pin supersedes the state of the Driver Disable pin. Supply current drops to 1.5mA when in DRIVER DISABLE mode.

V⁺: Positive Supply Output (RS232 Drivers). $V^+ \approx 2V_{CC} - 1.5V$. This pin requires an external charge storage capacitor $C \geq 0.1\mu F$, tied to ground or V_{CC} . Larger value capacitors may be used to reduce supply ripple. With multiple transceivers, the V^+ and V^- pins may be paralleled into common capacitors. For large numbers of transceivers, increasing the size of the shared common storage capacitors is recommended to reduce ripple.

V⁻: Negative Supply Output (RS232 Drivers). $V^- \approx -(2V_{CC} - 2.5V)$. This pin requires an external charge storage capacitor $C \geq 0.1\mu F$. V^- is short-circuit proof for 30 seconds.

C1⁺, C1⁻, C2⁺, C2⁻: Commutating Capacitor Inputs. These pins require two external capacitors $C \geq 0.2\mu F$: one from C1⁺ to C1⁻ and another from C2⁺ to C2⁻. To maintain charge pump efficiency, the capacitor's effective series resistance should be less than 2Ω. Low ESR ceramic capacitors work well in this application.

DRIVER IN: RS232 Driver Input Pins. These inputs are TTL/CMOS compatible. Inputs should not be allowed to float. Tie unused inputs to V_{CC} .

DRIVER OUT: Driver Outputs at RS232 Voltage Levels. Driver output swing meets RS232 levels for loads up to 3k. Slew rates are controlled for lightly loaded lines. Output current capability is sufficient for load conditions up to 2500pF. Outputs are in a high impedance state when in shutdown mode, $V_{CC} = 0V$ or when the driver disable pin is active. Outputs are fully short-circuit protected from $V^- + 25V$ to $V^+ - 25V$. Applying higher voltages will not damage the device if the overdrive is moderately current limited. Short circuits on one output can load the power supply generator and may disrupt the signal levels of the other outputs. The driver outputs are protected against ESD to ±5kV for human body model discharges.

TYPICAL APPLICATIONS

Typical Mouse Driving Application

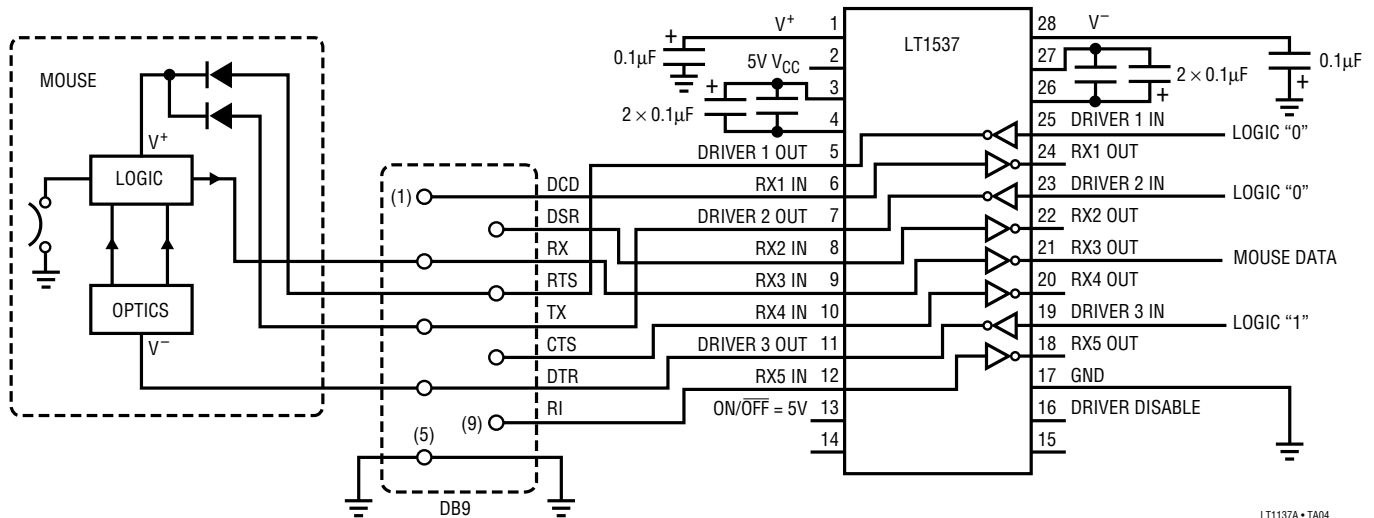

LT1137A • TA04

PACKAGE DESCRIPTION

Dimensions in inches (millimeters) unless otherwise noted.

G Package 28-Lead SSOP

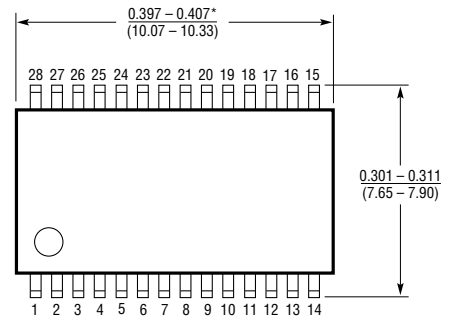
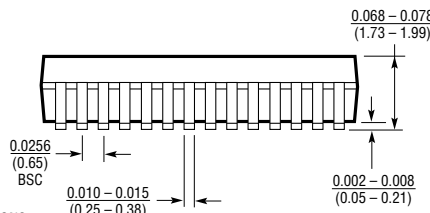
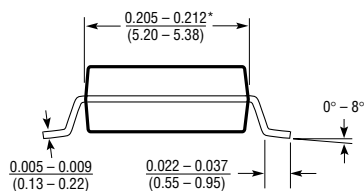

*THESE DIMENSIONS DO NOT INCLUDE MOLD FLASH OR PROTRUSIONS. MOLD FLASH OR PROTRUSIONS SHALL NOT EXCEED 0.006 INCH (0.15mm).

28SSOP 0894

S Package 28-Lead Plastic SOL

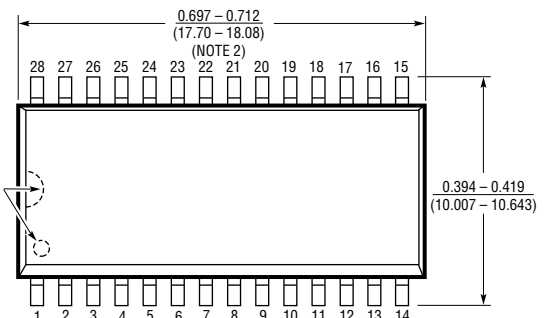
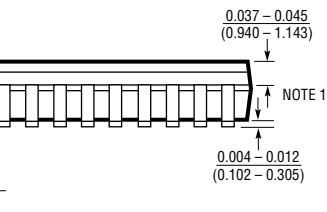
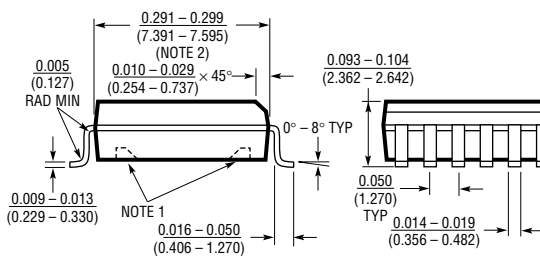

NOTE:

1. PIN 1 IDENT, NOTCH ON TOP AND CAVITIES ON THE BOTTOM OF PACKAGES ARE THE MANUFACTURING OPTIONS. THE PART MAY BE SUPPLIED WITH OR WITHOUT ANY OF THE OPTIONS. 2. THESE DIMENSIONS DO NOT INCLUDE MOLD FLASH OR PROTRUSIONS. MOLD FLASH OR PROTRUSIONS SHALL NOT EXCEED 0.006 INCH (0.15mm).

SOL28 0392

RELATED PARTS

PART NUMBER	DESCRIPTION	COMMENTS
LT1137A	5V 3-Driver/5-Receiver RS232 Transceiver with Shutdown	Premium Performance Upgrade to LT1537
LT1138A	5V 5-Driver/3-Receiver RS232 Transceiver	Premium Performance DCE, Compliment to LT1537
LT1237	5V 3-Driver/5-Receiver RS232 Transceiver with One Receiver Active in Shutdown	Lower Power, Premium Performance Upgrade to LT1537
LT1330	5V 3-Driver/5-Receiver RS232 Transceiver with 3V Logic Interface and Shutdown	Premium Performance Device for 5V Systems with 3V Logic Supplies
LT1331	5V 3-Driver/5-Receiver RS232 Transceiver with 3V Logic Interface and Receiver Active in Shutdown	LT1330 with Low Power Receiver That Stays Active During Shutdown
LTC1337	Ultra-Low Power 5V 3-Driver/5-Receiver RS232 Transceiver with Shutdown	Ultra-Low Power, Premium Performance Upgrade to LT1537
LTC1338	5V 5-Driver/3-Receiver RS232 Transceiver with Shutdown	Ultra-Low Power, Peripheral-Side Compliment to LT1537